

Design of Power System Stabilizer for AL-UMRA Power Plant

ABDULAZIZ M. JALAL and AHMED S. ABDUL WAHAB
*Department of Electrical and Computer Engineering,
Faculty of Engineering, King Abdulaziz University,
Jeddah, Saudi Arabia*

ABSTRACT. Design of a power system stabilizer for Al-Umra power system is proposed. A linear model for the power system is presented and analysed. The eigenvalue analysis of the model has shown the existence of an unstable mechanical mode. To overcome this instability problem, a power system stabilizer based on a lead-lag compensator is introduced. Parameters of the proposed power system stabilizer have been chosen and tuned carefully in order to give the system an adequate performance. Digital time simulations indicate that the stabilizer has resulted in a significant improvement in system performance.

1. Introduction

Control of power systems proceeds from the control of the mechanical power sources (primarily hydro and thermal sources) to the control of the generators, network connections, and other devices in the system. The control objectives are mainly to help maintain frequency, power balance, voltage level and system stability. At the generator level, the control of mechanical power proceeds at a relatively slow rate. The exciter can have response times in the fraction of a second range and therefore can be considered the first line of defense in maintaining system dynamic stability. The exciter has a direct effect on the generator voltage levels, and can therefore also affect the power angle as well as the current. It can indirectly affect the real power and system frequency. However, the high gain required by the voltage regulator for a good and fast response of the excitation system often leads to reduction in system damping. This results in an under damped low frequency power and speed oscillations which are very difficult to control and have an adverse effect on system stability. One way to damp

these oscillations is to introduce additional damping by injecting a stabilizing signal through the excitation system as shown in Fig. 1. The stabilizing signal is obtained through a Power System Stabilizer (PSS) hardware which is specifically designed and tuned in order to damp out the above-mentioned oscillations.

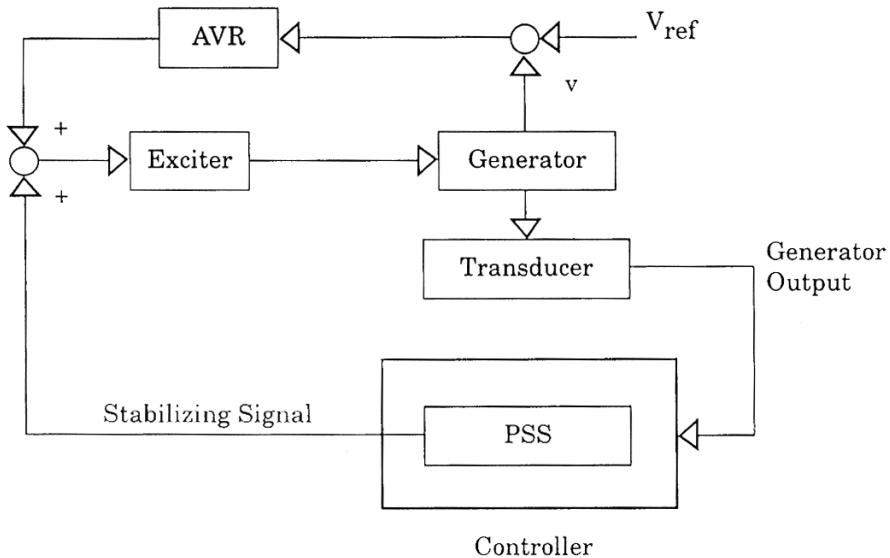

FIG. 1. Generating unit power system stabilizer.

One famous power system stabilizer which can be applied to a wide range of machine parameters was developed by Demello and Concordia^[1]. It has for a long time received some acceptance among the power system stabilizer designers. This stabilizer uses the generator speed deviation to derive the stabilizing signal through a simple compensator with a double lead-lag transfer function. Another type of a PSS that uses a digital rather than an analogue implementation, has also been reported^[2] and shown to be of an acceptable damping effect.

Several other approaches have also been used to design different forms of fixed-parameter PSS. One of those approaches used the pole placement technique^[3-6], where the stabilizer parameters are designed by properly placing the closed loop system poles to give the damping needed. Some other designs of the PSS have also been designed based on the linear optimal control theory^[7-10]. The fixed parameters of the stabilizer are designed to minimize a selected performance criterion which reflects the desired dynamic characteristics without an explicit study of the system modes. Among other approaches in designing a fixed-parameter PSS are the use of proportional-integral-derivative (PID) con-

tro[¹¹], in which the parameters of the (PID) stabilizer are determined to satisfy a desired performance; and the use of the variable structure control[¹²], where the parameters of the optimal variable structure index are obtained with a sliding mode technique.

$$A = \begin{bmatrix} \frac{k_6}{T_{d0}k_3} * [\frac{k_1}{k_2k_5 - k_1k_6} + \frac{k_2k_3k_4}{k_1k_6 - k_2k_5}] & 377k_5 & \frac{k_6}{T_{d0}k_3} * [\frac{k_3k_4k_6}{k_1k_6 - k_2k_5} + \frac{k_5}{k_2k_5 - k_1k_6}] & \frac{k_6}{T_{d0}k_3} & 0 \\ 0 & 0 & \frac{1}{M} & 0 & 0 \\ \frac{k_2}{T_{d0}k_3} * [\frac{k_5}{k_2k_5 - k_1k_6} + \frac{k_6k_4k_3}{k_1k_6 - k_2k_5}] & 377k_1 & \frac{k_2}{T_{d0}k_3} * [\frac{k_3k_4k_6}{k_1k_6 - k_2k_5} + \frac{k_5}{k_2k_5 - k_1k_6}] & \frac{k_2}{T_{d0}k_3} & 0 \\ \frac{-k_a}{T_A} & 0 & 0 & \frac{-k_a}{T_A} & \frac{-1}{T_A} \\ \frac{k_5k_A}{T_fT_A} & 0 & 0 & \frac{-k_a}{T_A} & \frac{-1}{T_A} \end{bmatrix}$$

and

$$B = \begin{bmatrix} 0 & 0 & 0 & \frac{k_A}{T_A} & \frac{K_f K_A}{T_f T_A} \end{bmatrix}$$

In this paper the effect of low-frequency oscillations in the performance of Al-Umra power generation will be studied. Eigenvalues for the power system plant will be analyzed. Then a power system stabilizer (PSS) is designed in order to damp these oscillations and enhance the performance of the power plant.

2. Power System Model and Analysis

The linearized model for a single machine connected to an infinite bus as shown in Fig. 2 can be represented by the following state space form[¹³].

$$\dot{x} = Ax + Bu \quad (1)$$

where x is the generator state variable $[\Delta V_t, \Delta \omega, \Delta Te, \Delta V_f, \Delta E_{fd}]$

u is the input

In this section the analysis of a real system is presented. Its data is based on information provided by the engineering staff of AL-UMRA power station in Makkah city Saudi Consolidated Electrical Companies west[¹⁴].

The system operates with gas turbine engine and its specifications are as follows:

Rated voltage	=	13.8 kV	Peo	=	0.8 pu
Output	=	115 MVA	Qeo	=	0.6 pu
Power Factor	=	.8			

Rated Current = 4832 A $V_{e0} = 1$ pu
 Speed = 3000 rpm.

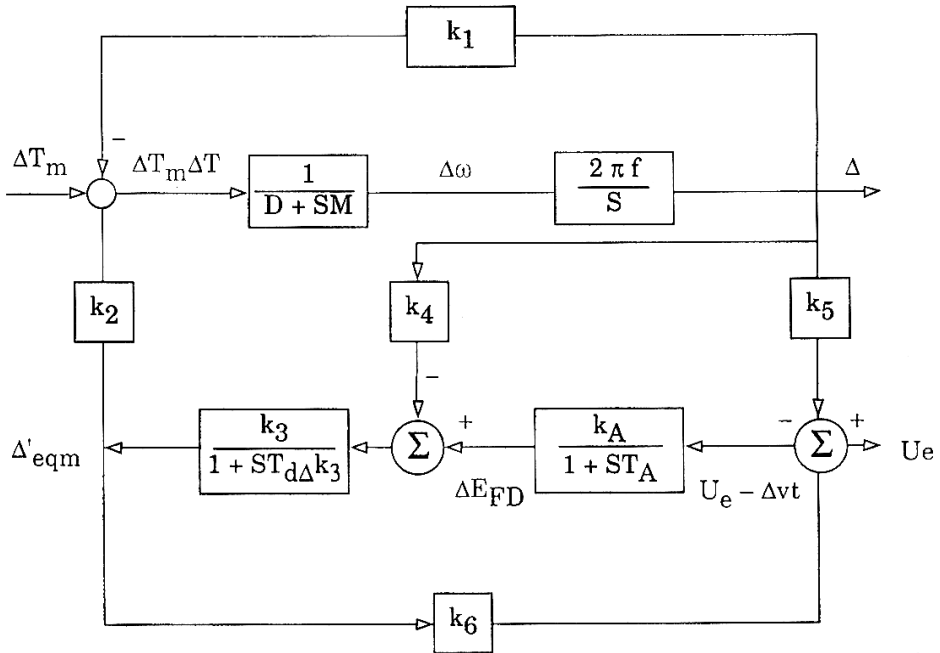

FIG. 2. Block diagram for a single machine connected to an infinite bus.

Hence, model parameters can be determined as follows (SI units are assumed throughout) :

$K_1 = .4867$	$K_A = 50$	$D = 0$
$K_2 = .2561$	$T_A = .3$	$e_{FD, MAX} = 7.3$
$K_3 = 2.5908$	$T_{do}^2 = 9$	$e_{FD, MIN} = -7.3$
$K_4 = .6736$	$M = 9.26$	$U_{MAX} = .12$
$K_5 = -.7268$	$K_F = .03$	$U_{MAX} = -.12$
$K_6 = .3186$	$T_F = 1$	

$$A = \begin{bmatrix} -.00159 & -274.024 & -0.514 & 0.354 & 0 \\ 0 & 0 & .108 & 0 & 0 \\ -.00128 & 183.49 & -.0413 & .0285 & 0 \\ 166.67 & 0 & 0 & -3.33 & -166.67 \\ -5 & 0 & 0 & -.1 & -6 \end{bmatrix}$$

$$B = [0 \quad 0 \quad 0 \quad 167 \quad 5]$$

By using (MATLAB) we obtained the numerical values for the open loop eigenvalues of the system analysed as listed in Table 1.

TABLE 1. Eigenvalue analysis.

- 8.1012		
0.3527	+	J 4.3254 i
0.3527	-	J 4.3254 i
- 0.9885	+	J 0.8438 i
- 0.9885	-	J 0.8438 i

From the eigenvalue analysis for a single machine-infinite bus system, it can be seen that the first, the fourth and the fifth eigenvalues represent the electrical mode. It is clear that the instability is caused by the mechanical mode. Digital simulation of various system responses versus time are presented in Figs. 3 through 7 given that a mechanical torque disturbance of 2.5 percent is applied.

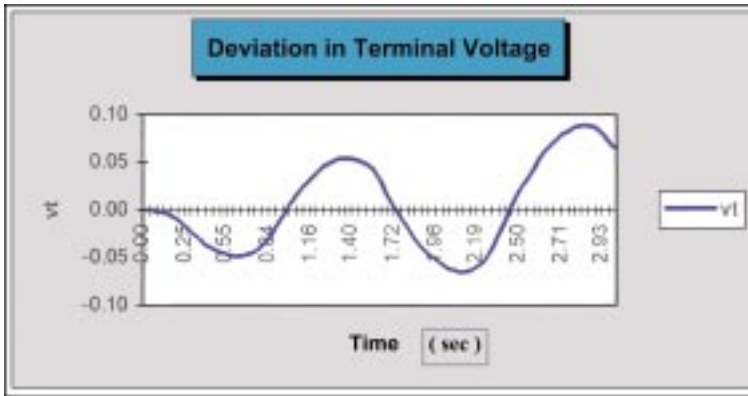

FIG. 3. Terminal voltage response for $\Delta T_m = 2.5\%$ without control ($u = 0$).

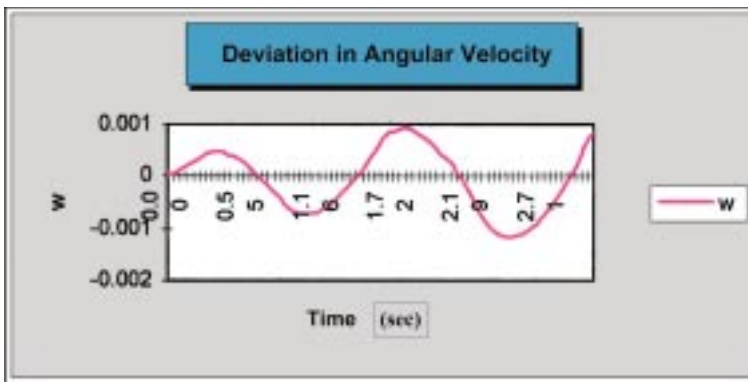

FIG. 4. Angular velocity response for $\Delta T_m = 2.5\%$, without control.

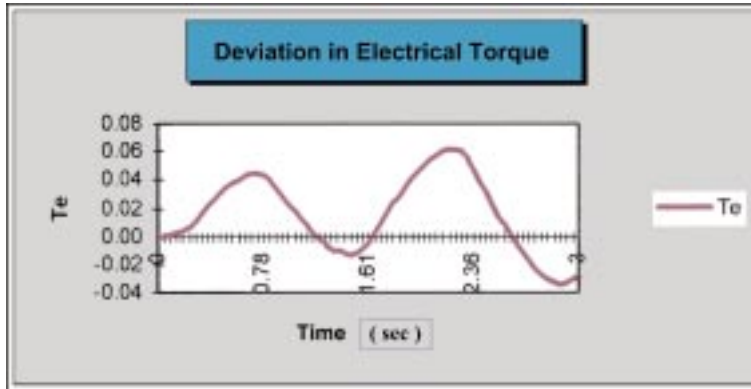

FIG. 5. Electrical torque response for $\Delta T_m = 2.5\%$, without control.

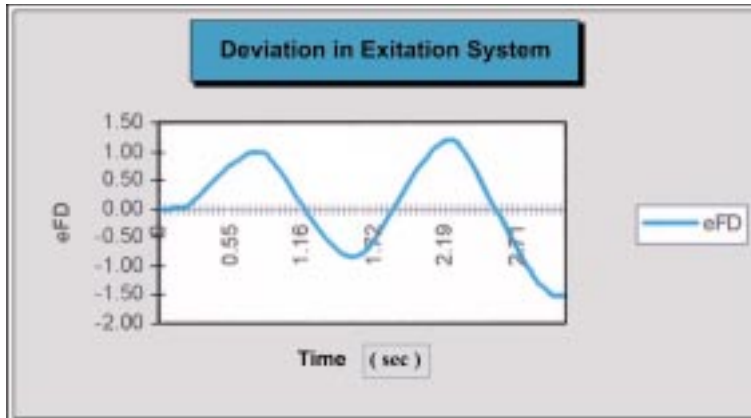

FIG. 6. Excitation system voltage response for $\Delta T_m = 2.5\%$, without control.

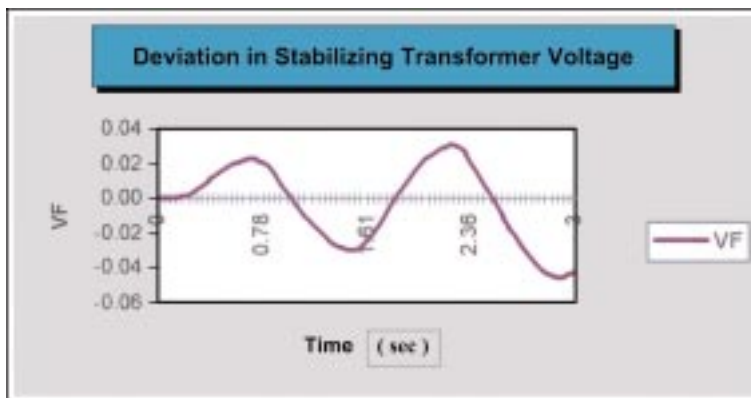

FIG. 7. Stabilizing transformer voltage response for $\Delta T_m = 2.5\%$, without control.

From these figures it has been found that the deviations in terminal voltage, angular velocity, electrical torque, excitation system deteriorating responses and stabilizing transformer voltage start to increase which is a clear sign of system instability.

3. Design Procedure for the Power System Stabilizer :

Supplementary excitation control of low frequency oscillations is known as a power system stabilizer. Such a stabilizer consists of several stages that are shown in Fig. 8. The idea is to apply a supplementary signal through the excitation system to increase the damping torque of the generator power system. For a single machine connected to an infinite bus, the supplementary control signal is applied through the T_a , T_{do} and K blocks in order to obtain the extra damping ΔT_E . One of the power system stabilizer techniques is the lead-lag compensator. The phase lag of $(1 + ST_{do})$, beside a phase lead, must be included in the supplementary signal so as to have a damping torque, DTe in phase with shaft speed Dw at the oscillating frequency. The compensation must have a gain to get an adequate magnitude of damping^[15].

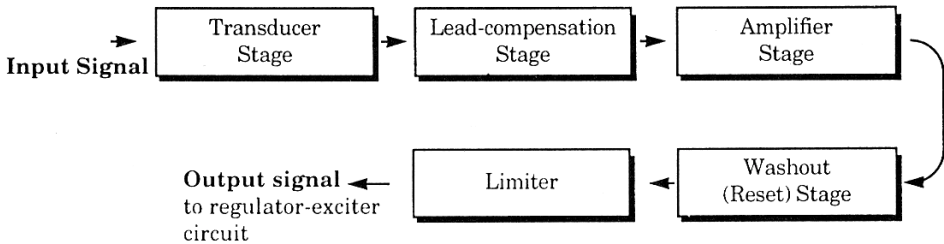

FIG. 8. Power system stabilizer.

For the PSS designed in this paper the following procedure has been used: -

1. A value of $\omega_n = 4.451$ has been determined from the equation :

$$\omega_n = \sqrt{\omega_b K_1 M} \quad (2)$$

where ω_n is the undamped natural frequency, ω_b is the system frequency, $2\pi f$ K_1 is the system parameters constant and M is the inertia constant in seconds.

2. The phase angle of G_E at $S = j\omega_n$ can be obtained using equation (3)

$$G_E = (K_A * K_3) / ((1 + ST_A) * (1 + S T'_{do} * K_3) + K_A * K_3 * K_6) \quad (3)$$

and phase lag of $G_E = \angle G_E | S = j\omega_n$

by substituting the values of all constants we found that ;

$$|G_E| = < .909 < -132.45 = |G_E| < G_E$$

therefore, the phase lag of $G_E = -132.45$ deg. has to be taken.

3. Finding the phase lead $< G_C$ which will compensate the effect of the phase lag $< G_E$. The angle G_C must satisfy the condition of

$$< (G_C + G_E) = 0 \quad (4)$$

then by using eq. (4). The values of n , $T1$ and $T2$ are estimated using equation (5)

$$G_C = \left(\frac{2 + ST1}{1 + ST2} \right)^n \quad (5)$$

For

$$n = 2, T1 = 0.58, \text{ and } T2 = 0.01$$

4. The amplifier gain can be determined by using the equation (6)

$$K = \frac{2 \xi_n \omega_n M}{K_2 / G_C(j\omega_n) | G_E(j\omega_n)} \quad (6)$$

5. The parameters have been tuned in order to have adequate damping to the system.

$$G_{\text{RESET}} = \frac{ST}{1 + ST} \quad (7)$$

4. Simulation and Results

The proposed PSS has been tested on a single machine-connected to an infinite bus. The system has been subjected to 2.5% disturbance on the mechanical torque. The simulation results have been displayed in Figs. 9 through 13.

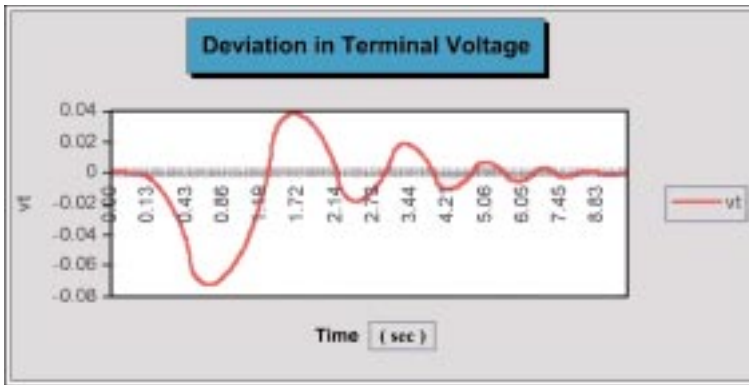

FIG. 9. Terminal voltage response for $\Delta T_m = 2.5\%$, with conventional power system stabilizer connected.

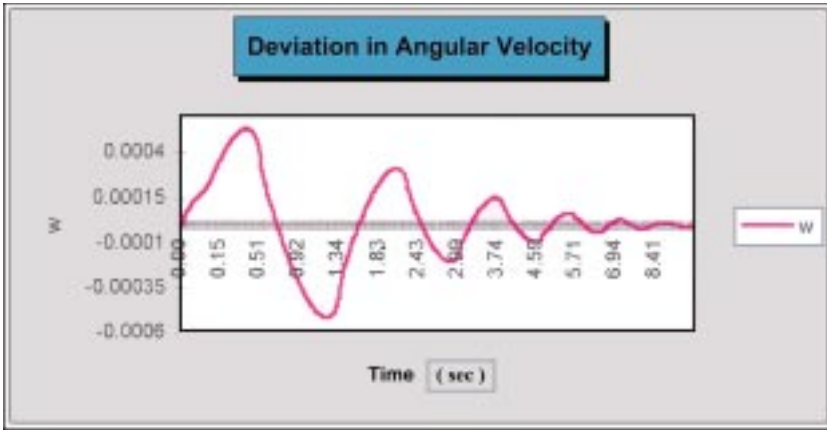

FIG. 10. Angular velocity response for $\Delta T_m = 2.5\%$, with conventional power system stabilizer connected.

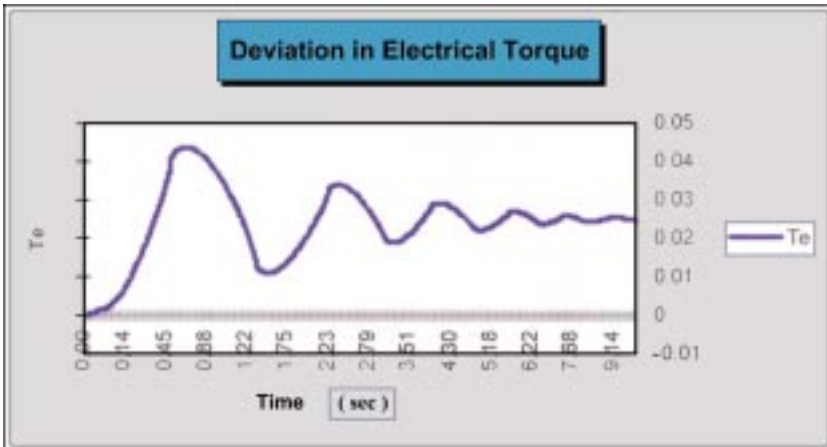

FIG. 11. Electrical torque response for $\Delta T_m = 2.5\%$, with conventional power system stabilizer connected.

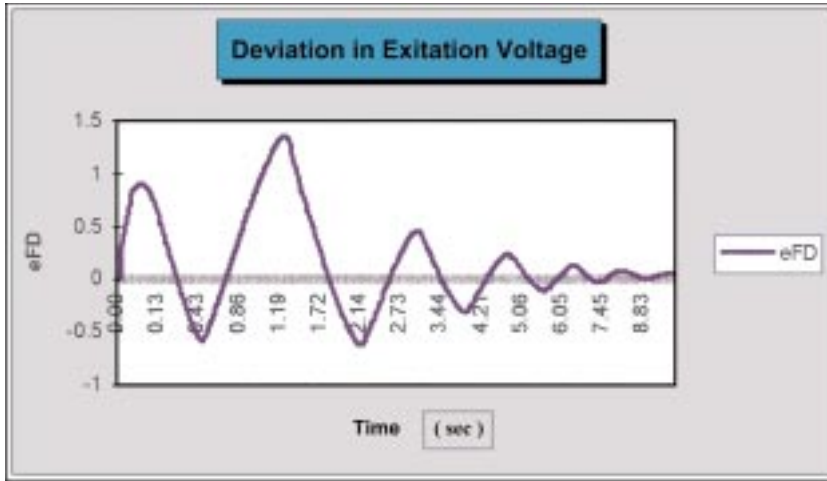

FIG. 12. Excitation system response for $\Delta T_m = 2.5\%$, with conventional power system stabilizer connected.

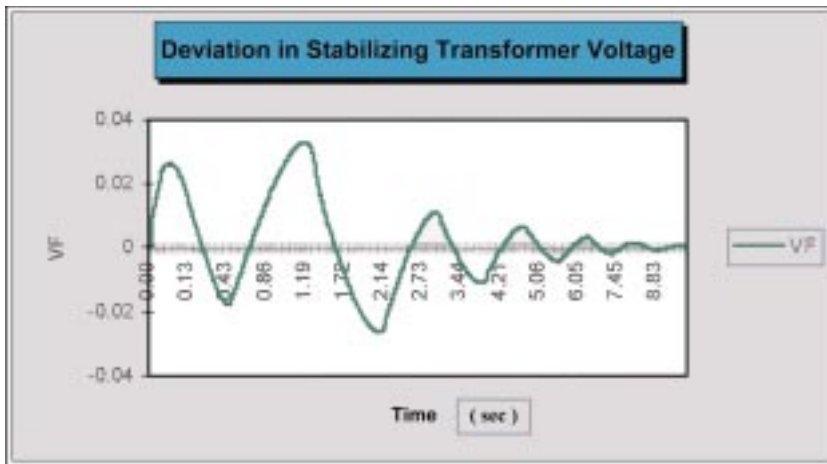

FIG. 13. Stabilizing transformer voltage response for $\Delta T_m = 2.5\%$, with conventional power system stabilizer connected.

Its is clear that the oscillations of the terminal voltage, angular velocity, electrical torque, excitation system and stabilizing transformer voltage are well damped, suppressed and the performance is enhanced. The closed loop poles for the proposed design are listed in Table (2). All the closed loop pole are on the left hand side of the S-plane.

TABLE 2. The system closed loop poles eigenvalues.

Eigenvalues without PSS	Eigenvalues with PSS connected
- 8.1012	- 7.335
0.3527 + j 4.3254	- 4.4857
0.3527 - j 4.3254	- 1.063
- 0.9885 + j 0.8438	- 0.8308 - j 4.871
- 0.9885 - j 0.8438	- 0.8308 + j 4.871

5. Conclusion

In this paper a power system stabilizer for Al-Umra Power Station has been designed. The basic function of the PSS is to provide extra damping to the machine through the excitation system. The parameters of the PSS are tuned carefully in order to have an adequate damping. The effect of the PSS is significant as it resulted in a much better performance for the system. All the closed loop poles of the system are stable. The practical application for the PSS is feasible. Comparisons with other PSS design techniques will be reported in the near future.*

References

- [1] **F.P. Demello** and **C. Concordia**, "Concepts of synchronous machine stability as affected by excitation control". *IEEE Trans. Power Appar. Syst.*; Vol. **PWRS 5**, pp. 353-358, 1969.
- [2] **A. Ghandakly** and **P. Kronger**, "Digital controller design method for synchronous generator excitation and stabilizer systems Part I: Methodology and computer simulation", *IEEE Trans. on Power Systems*, Vol. **PWRS-2**, pp. 633-637, 1987.
- [3] **J.H. Chow** and **J.J. Sanchez-Gasca** "Pole placement design for power system stabilizer", *IEEE Trans. on Power Systems*, Vol. **PWRS-4**, pp. 271-277, 1989.
- [4] **Y. Yu** and **Q. Li** "Pole placement power system stabilizer design of an unstable nine machine system", *IEEE Trans. on Power Systems*, Vol. **54**, pp. 815-829, 1991.
- [5] **A. M. Jalal**, **A.M. Farhoud** and **A. Ghandakly**, "Adaptive enhancement of synchronous generator stabilizer performance by including the external utility system dynamics". *The 1993 IEEE Industry Applications Society 28th Annual Meeting*, Toronto, Canada, pp. 1401-1408, 1993.

*The comparison of the performance of designed PSS for AL-UMRA power plant, with other design techniques will be reported in the forthcoming paper, which we are preparing right now.

- [6] **A.M. Farhoud** and **A.M. Jalal**, "Adaptive enhancement of synchronous generator stabilizer performance using a parameter optimization technique". *The 1993 IEEE Industry Applications Society 28th Annual Meeting*, Toronto, Ontario, Canada, pp. 147-154, 1993.
- [7] **L.T. Haung**, **S.C. Chen**, **T.Y. Hwang** and **W.T. Yang**, "Power system output feedback stabilizer design via optimal subeigen structure assignment". *IEEE Trans. on Power Systems*, Vol. **PWRS-6**, pp. 1035-1041, 1991.
- [8] **A.J. Urdaneta**, **N.J. Bacalao**, **B. Feijo**, **L. Flores** and **R. Diaz**, "Tuning of power system stabilizers using optimization techniques". *IEEE Trans. on Power Systems*, Vol. **PWRS-6**, pp. 127-134, 1991.
- [9] **H.A. Moussa** and **Y.N. Yu**, "Optimal power system stabilization through excitation and/or governor control". *IEEE Trans. on Power Apparatus and Systems*, Vol. **PAS-91**, pp. 1166-1174, 1971.
- [10] **V.H. Quintana**, **M.A. Zohdy** and **J.H. Anderson**, "On the design of output feedback excitation controllers of synchronous machines". *IEEE Trans. on Power Apparatus and Systems*, Vol. **PAS-95**, pp. 954-961, 1976.
- [11] **Y.Y. Hsu** and **C.Y. Hsu**, "Design of a proportional integral power system stabilizer". *IEEE Trans. on Power Systems*, Vol. **PWRS-1**, pp. 46-53, 1986.
- [12] **W.C. Chan** and **C.Y. Hsu**, "An optimal variable structure stabilizer for power system stabilization". *IEEE Trans. on Power Apparatus and Systems*, Vol. **PAS-102**, pp. 1738-1746, 1983.
- [13] **P.M. Anderson** and **A.A. Fouad**, "*Power System Control and Stability*". Iowa State University Press, Ames, Iowa, U.S.A., 1986.
- [14] **A.S. Abdullwahab**, "*Conventional Power System Stabilizer Design for Umra Power Plant, Report*", Faculty of Engineering, Department of Electrical and Computer Engineering, King Abdulaziz University, Jeddah, 1416.
- [15] **Yao-Nan Yu**, "*Electric Power System Dynamics*", Academic Press. 1983.

تصميم جهاز موازن لنظام القدرة الكهربائية لمحطة العمرة لتوليد القدرة الكهربائية

عبد العزيز جلال و أحمد عبد الوهاب

قسم الهندسة الكهربائية وهندسة الحاسبات ، كلية الهندسة ، جامعة الملك عبد العزيز
جدة - المملكة العربية السعودية

المستخلص . يعرض هذا البحث تصميمًا مقترحًا لجهاز موازن لنظام القدرة الكهربائية لمحطة العمرة لتوليد القدرة الكهربائية . وقد تم اعداد وتحليل نموذج خطي لنظام القدرة الكهربائية ، وتبين من تحليل القيمة الذاتية للنموذج وجود شكل ميكانيكي غير ثابت . وللتغلب على مشكلة عدم الثبات يقدم البحث جهازاً موازناً (مثبتاً) لنظام القدرة الكهربائية تم اعداده على أساس معادل للتخلف المتقدم . وقد تم اختيار معالم الجهاز الموازن لنظام القدرة الكهربائية وضبطها وموافتها بعناية من أجل توفير الأداء المناسب لنظام القدرة الكهربائية . وأظهرت نماذج المحاكاة الزمنية الرقمية أن استخدام الموازن أدى إلى حدوث تحسن له وزنه في أداء النظام .